

Refletores Fita Isolante Conectores Bases para Lâmp
Suporte para TV Alarmes e Anunciadores Luminária
Terminais Antenas Alarmes e Anunciadores Plugues



Refletores Fita Isolante Conectores Bases para Lâmp
Suporte para TV Alarmes e Anunciadores Luminária
Terminais Antenas Alarmes e Anunciadores Plugues
Luminárias Abraçadeira de Nylon Temporizadores



Refletores Fita Isolante Conectores Bases para Lâmp
Suporte para TV **Catálogo de Produtos 2016** Bocais p
Terminais Antenas Alarmes e Anunciadores Plugues
Luminárias Abraçadeira de Nylon Temporizadores

índice

Lâmpada Bulbo A60 LED

Economia
de **85%** de energia



Embalagem atrativa para PDV

TABELA DE EQUIVALÊNCIA

LED	9W	30W
LED 5W	9W	30W
LED 7W	13W	40W
LED 9W	16W	60W
LED 12W	20W	75W

Base: E27

Autovolt: 127V e 220V

Vida mediana: 30.000 horas

Tecnologia livre de Mercúrio (Hg)

Posição de funcionamento universal

CÓDIGO	DESCRIÇÃO	BASE	POTÊNCIA	TEMPERATURA DE COR	EMBALAGEM	
					MID.	MASTER
LLD 60605	Lâmpada Bulbo A60 LED	E27	5 W	6.500 K	10 un.	50 un.
LLD 60307	Lâmpada Bulbo A60 LED	E27	7 W	3.000 K	10 un.	50 un.
LLD 60607	Lâmpada Bulbo A60 LED	E27	7 W	6.500 K	10 un.	50 un.
LLD 60309	Lâmpada Bulbo A60 LED	E27	9 W	3.000 K	10 un.	50 un.
LLD 60609	Lâmpada Bulbo A60 LED	E27	9 W	6.500 K	10 un.	50 un.
LLD 60312	Lâmpada Bulbo A60 LED	E27	12 W	3.000 K	10 un.	50 un.
LLD 60612	Lâmpada Bulbo A60 LED	E27	12 W	6.500 K	10 un.	50 un.

Lâmpada Tubular LED T8

6.500 K / 18 W
LLT 28618



6.500 K / 9 W
LLT 28609



Autovolt: 127V e 220V

Vida mediana: 25.000 horas

Tecnologia livre de Mercúrio (Hg) e livre Chumbo

Temperatura de cor: 6.500 K (Branca Fria)

CÓDIGO	DESCRIÇÃO	BASE	POTÊNCIA	TEMPERATURA DE COR	EMBALAGEM
					MASTER
LLT 28609	Lâmpada Tubular LED T8	T8	9 W	6.500 K	25 un.
LLT 28618	Lâmpada Tubular LED T8	T8	18 W	6.500 K	25 un.



Luz Noturna LED



MultiColor

Branca



Embalagem atrativa para PDV

Fotocélula integrada: Liga e desliga automaticamente

Vida mediana do LED: ~10.000 horas

Potência máxima: 0,4 W

CÓDIGO	TENSÃO	COR	EMBALAGEM	
			MID.	MASTER
LNL 11103	127 V	Branca	28 un.	84 un.
LNL 11201	127 V	Azul, Verde e Vermelho	28 un.	84 un.
LNL 21103	220 V	Branca	28 un.	84 un.
LNL 21201	220 V	Azul, Verde e Vermelho	28 un.	84 un.

Luz Noturna Divertida LED

Autovolt (110 V a 240 V)

Com chave Liga / Desliga

Vida mediana do LED: ~10.000 horas

Potência máxima: 1 W

CÓDIGO	MODELO	EMBALAGEM	
		MID.	MASTER
LDL 30111	Gato	10 un.	60 un.
LDL 30112	Leão	10 un.	60 un.
LDL 30113	Ovelha	10 un.	60 un.
LDL 30114	Pinguim	10 un.	60 un.
LDL 30115	Sapo	10 un.	60 un.
LDL 30116	Urso	10 un.	60 un.



Embalagem atrativa para PDV



Gato



Leão



Ovelha



Pinguim



Sapo



Urso

Luz Guia LED 1 W Autovolt

Potência máxima: 1 W
 Autovolt (110 V a 240 V)
 Com chave Liga / Desliga
 Vida mediana do LED: ~10.000 horas

**Iluminação
 Suave e
 econômica**



Luz Guia LED 1 W
 LGL 30111



Embalagem atrativa para PDV

CÓDIGO	POTÊNCIA MÁXIMA	COR	EMBALAGEM	
			MID.	MASTER
LGL 30111	1 W	Branca	10 un.	60 un.

Espeto de Jardim

Para lâmpadas PAR 20/30/38 rosca e-27
 Potência máxima: 120 W
 Para uso externo
 Não acompanha lâmpada

**Articulável
 e Variável**

CÓDIGO	COR	POTÊNCIA MÁXIMA	EMBALAGEM MASTER
LEJ 20116	Preta	120 W	30 un.
LEJ 20117	Verde	120 W	30 un.

Preto
 LEJ 20116



Verde
 LEJ 20116



Luminária de Mesa Articulável com Base

Para lâmpadas incandescentes e fluorescentes compactas e-27

Potência máxima: 60 W

Não acompanha lâmpada

CÓDIGO	BASE	COR	EMBALAGEM
			MASTER
LMA 10112	Base	Azul	10 un.
LMA 10113	Base	Branca	10 un.
LMA 10114	Base	Cinza	10 un.
LMA 10116	Base	Preta	10 un.
LMA 10117	Base	Verde	10 un.
LMA 10118	Base	Vermelha	10 un.



Branco
LMA 10113

Cinza
LMA 10114

Azul
LMA 10112

Vermelho
LMA 10118

Verde
LMA 10117

Preto
LMA 10116

Luminária de Mesa Articulável com Garra

Para lâmpadas incandescentes e fluorescentes compactas e-27

Potência máxima: 60 W

Não acompanha lâmpada

CÓDIGO	BASE	COR	EMBALAGEM
			MASTER
LMA 20112	Garra	Azul	10 un.
LMA 20113	Garra	Branca	10 un.
LMA 20114	Garra	Cinza	10 un.
LMA 20116	Garra	Preta	10 un.
LMA 20117	Garra	Verde	10 un.
LMA 20118	Garra	Vermelha	10 un.



Branco
LMA 10113

Cinza
LMA 10114

Azul
LMA 10112

Vermelho
LMA 10118

Verde
LMA 10117

Preto
LMA 10116

Luminária de Mesa Flex com Base

Para lâmpadas incandescentes e fluorescentes compactas e-27

Potência máxima: 60 W

Não acompanha lâmpada

CÓDIGO	BASE	COR	EMBALAGEM
			MASTER
LMF 10112	Base	Azul	20 un.
LMF 10113	Base	Branca	20 un.
LMF 10114	Base	Cinza	20 un.
LMF 10116	Base	Preta	20 un.
LMF 10117	Base	Verde	20 un.
LMF 10118	Base	Vermelha	20 un.



Luminária de Mesa Flex com Garra

Para lâmpadas incandescentes e fluorescentes compactas e-27

Potência máxima: 60 W

Não acompanha lâmpada

CÓDIGO	BASE	COR	EMBALAGEM
			MASTER
LMF 20113	Garra	Branca	20 un.
LMF 20116	Garra	Preta	20 un.



Luminária de Mesa Pelicano

Para lâmpadas incandescentes e fluorescentes compactas e-27

Potência máxima: 60 W

Não acompanha lâmpada

CÓDIGO		COR	EMBALAGEM
127 V	220 V		MASTER
LPE 10911	LPE 20911	Amarela	30 un.
LPE 10912	LPE 20912	Azul	30 un.
LPE 10913	LPE 20913	Branca	30 un.
LPE 10914	LPE 20914	Cinza	30 un.
LPE 10916	LPE 20916	Preta	30 un.
LPE 10917	LPE 20917	Verde	30 un.
LPE 10918	LPE 20918	Vermelha	30 un.



Luminária Blindada IP-65

Para lâmpadas fluorescentes T10, T8 e T5
 Proteção IP-65: Contra água, pó, insetos e vapores
 Difusor em policarbonato: Resistente a impactos
 Anticorrosiva: Proteção contra maresia
 Clipes e corpo em ABS: Maior durabilidade

Anticorrosiva

2 Tirantes Plásticos



2 Prensa Cabos



Difusor Basculante



Clipes embutidos



Ideal para:
 Indústrias, depósitos, cozinhas,
 restaurantes, frigoríficos, garagens,
 áreas externas, litoral, etc.

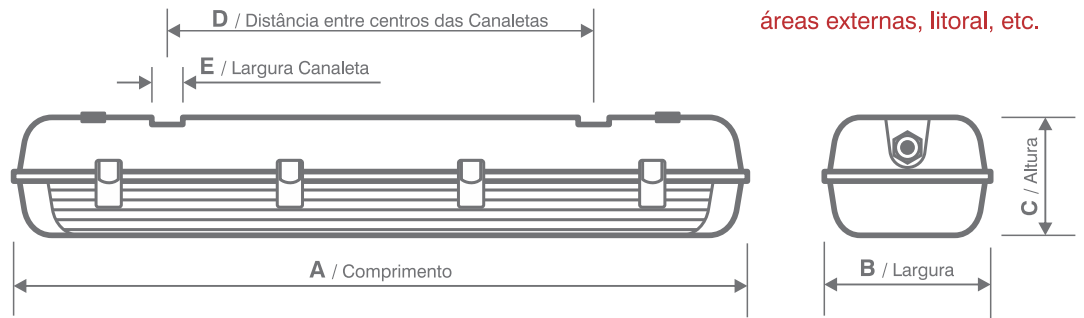

CÓDIGO	PARA LÂMPADAS				DIMENSÕES					EMBALAGEM
	T5	T8	T8	T10	A	B	C	D	E	MASTER
LBF 11120	1 x 14 W	1 x 16 W	1 x 18 W	1 x 20 W	655 mm	76 mm	88 mm	470 mm	40 mm	12 un.
LBF 11140	1 x 28 W	1 x 32 W	1 x 36 W	1 x 40 W	1.270 mm	76 mm	88 mm	835 mm	65 mm	9 un.
LBF 11158	---	1 x 58 W	---	---	1.562 mm	85 mm	93 mm	948 mm	30 mm	6 un.
LBF 11220	2 x 14 W	2 x 16 W	2 x 18 W	2 x 20 W	655 mm	120 mm	88 mm	470 mm	40 mm	8 un.
LBF 11240	2 x 28 W	2 x 32 W	2 x 36 W	2 x 40 W	1.270 mm	120 mm	88 mm	835 mm	65 mm	6 un.

Clipes em Aço



Clipe opcional para Luminária Blindada IP-65
 Não acompanha a Luminária, vendido separadamente

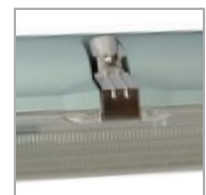

Clipe instalado

Ideal para:
 Ambientes agressivos, com temperaturas
 extremas: Frigoríficos e cozinhas

CÓDIGO	MODELO	EMBALAGEM	
		MID.	MASTER
LBF 90111	Clipe em aço	20 un.	200 un.

Refletor para Lâmpada Halógena

Classe de proteção: IP-55

Vidro Temperado

Base da lâmpada: R7s

CÓDIGO	POTÊNCIA MÁXIMA	COR	EMBALAGEM
			MASTER
RLH 10153	150 W	Branca	24 un.
RLH 10156	150 W	Preta	24 un.
RLH 10503	300 / 500 W	Branca	16 un.
RLH 10506	300 / 500 W	Preta	16 un.



150 W Branco
RLH 10153



150 W Preto
RLH 10156



300 / 500 W Branco
RLH 10503



300 / 500 W Preto
RLH 10506

Refletor Externo para Lâmpada HQI 150W

Soquete ajustável para lâmpadas de 70 W e 150 W

Potencia máxima: 150 W

Base da lâmpada: Rx7s

Classe de proteção: IP-65

Corpo em alumínio injetado

Vidro temperado

Assimétrico

Com alojamento interno para reator

Não acompanha reator nem lâmpada



150 W Branco
RDS 11013



150 W Preto
RDS 11016

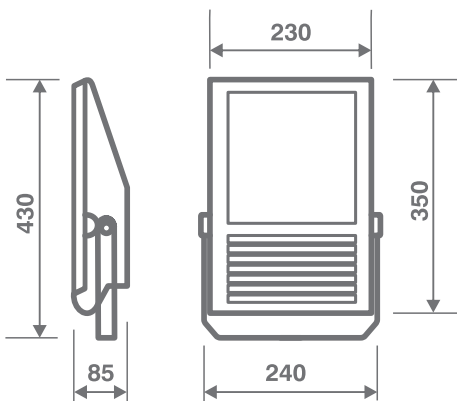

* Dimensões em milímetros

CÓDIGO	COR	POTÊNCIA MÁXIMA	EMBALAGEM MASTER
RDS 11013	Banca	150 W	4 un.
RDS 11016	Preta	150 W	4 un.

Refletor para Lâmpada HQI 250/400 W

Classe de proteção: IP-65

Com alojamento

Potência máxima: 400 W

Base da lâmpada: e-40

Não acompanha reator nem lâmpada

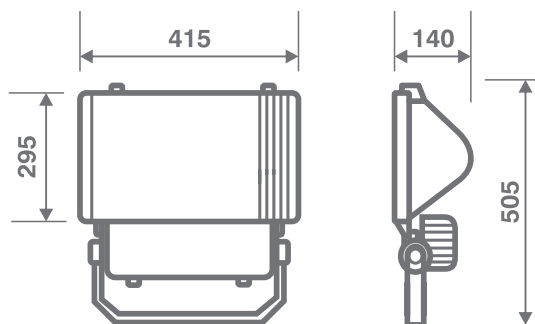

* Dimensões em milímetros



Simétrico
RDS 22046



Assimétrico
RDS 21046

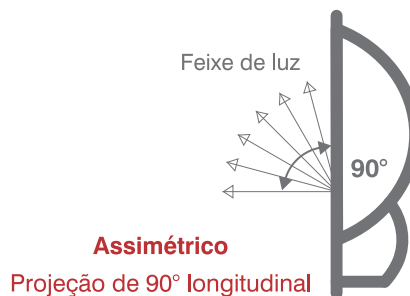
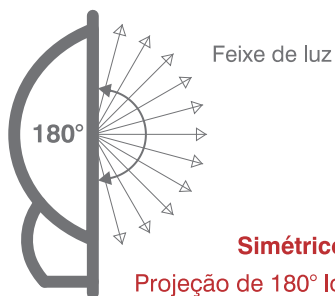

CÓDIGO	MODELO	COR	POTÊNCIA MÁXIMA	BOCAL	EMBALAGEM
					MASTER
RDS 21046	Assimétrico	Preta	400 W	e-40	3 un.
RDS 22046	Simétrico	Preta	400 W	e-40	3 un.

Refletor para Lâmpada HQI 250/400 W com Aba

Classe de proteção: IP-65
 Com alojamento
 Potência máxima: 400 W
 Base da lâmpada: e-40
 Não acompanha reator nem lâmpada

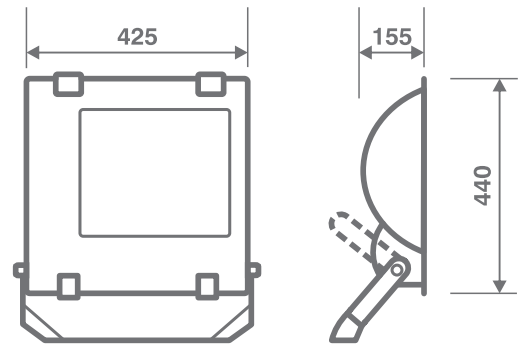

* Dimensões em milímetros



Simétrico Branco
RDS 31043

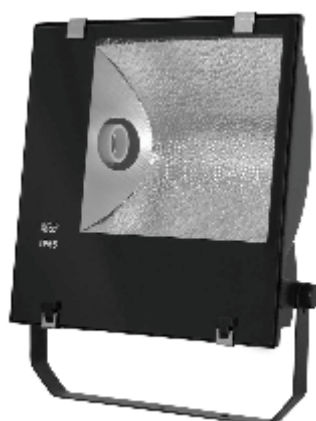

Simétrico Preto
RDS 31046

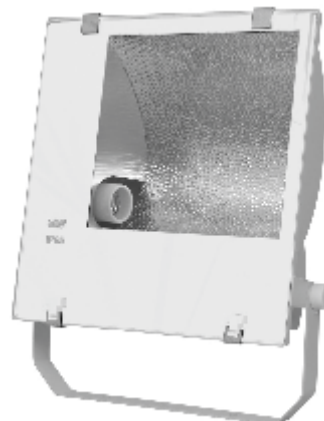

Assimétrico Branco
RDS 32043



Assimétrico Preto
RDS 32046

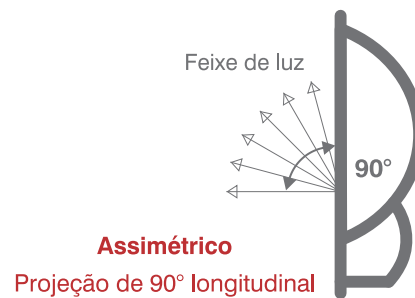

CÓDIGO	MODELO	COR	POTÊNCIA MÁXIMA	BOCAL	EMBALAGEM MASTER
RDS 31043	Assimétrico	Branca	400 W	e-40	1 un.
RDS 31046	Assimétrico	Preta	400 W	e-40	1 un.
RDS 32043	Simétrico	Branca	400 W	e-40	1 un.
RDS 32046	Simétrico	Preta	400 W	e-40	1 un.

Bases para Lâmpadas



Base AR70
BPL 11112



Base G5.3
BPL 12112



Base GZ10 e GU10
BPL 13112

CÓDIGO	BASE	POTÊNCIA MÁXIMA	EMBALAGEM	
			MID.	MASTER
BPL 11112	AR70	100 W	35 un.	560 un.
BPL 12112	G5.3	100 W	50 un.	1.600 un.
BPL 13112	GZ10 e GU10	100 W	35 un.	560 un.

Bases para Lâmpadas HQI

Atende às normas de segurança e qualidade do INMETRO



70 W
Com cabo 25 / 35 cm
BPL 18072



150 W
Com cabo 35 / 45 cm
BPL 18152

CÓDIGO	POTÊNCIA MÁXIMA	BASE	EMBALAGEM	
			MID.	MASTER
BPL 18072	70 W	RX7s	12 un.	192 un.
BPL 18152	150 W	RX7s	8 un.	128 un.

Bases para Lâmpadas Fluorescentes Tubulares

Base: G13
Corrente: 2 A
Tensão: 600 V

Anti Vibratório
BPL 14212



Base: G13
Corrente: 2 A
Tensão: 250 V

CÓDIGO	POTÊNCIA MÁXIMA	BASE	EMBALAGEM	
			MID.	MASTER
BPL 18072	70 W	RX7s	12 un.	192 un.
BPL 18152	150 W	RX7s	8 un.	128 un.

Cebolinha
BPL 14112



Adaptadores de Porcelana para Bocais

Atende às normas de segurança e qualidade do INMETRO
Acabamento em esmalte

CÓDIGO	MODELO	CORRENTE	EMBALAGEM	
			MID.	MASTER
APB 27403	Adaptador E27 para E40	4 A	25 un.	100 un.
APB 40273	Adaptador E40 para E27	4 A	25 un.	100 un.



E27 para E40
APB 27403



E40 para E27
APB 40273

Bocais Termoplásticos

Atende às normas de segurança e qualidade do INMETRO



Abajur Branco
BTE27023



Abajur Preto
BTE 27026



Fixo de Teto Branco
BTE 27033



Fixo de Teto Preto
BTE 27036



Pendente com Rabicho Preto
Com cabo de 11 cm
BTE 27086



Pendente com Rabicho Branco
Com cabo de 11 cm
BTE 27083



Com Pino Macho Preto
BTE 27106

CÓDIGO	DESCRIÇÃO	BASE	CORRENTE	FIOS E CABOS	EMBALAGEM	
					MID.	MASTER
BTE 27083	Pendente c/ Rabicho Branco	e-27	4 A	0,5 a 2,5 mm ²	50 un.	600 un.
BTE 27086	Pendente c/ Rabicho Preto	e-27	4 A	0,5 a 2,5 mm ²	50 un.	600 un.
BTE 27083	Pendente c/ Rabicho Branco	e-27	4 A	0,5 a 2,5 mm ²	50 un.	600 un.
BTE 27086	Pendente c/ Rabicho Preto	e-27	4 A	0,5 a 2,5 mm ²	50 un.	600 un.
BTE 27083	Pendente c/ Rabicho Branco	e-27	4 A	0,5 a 2,5 mm ²	50 un.	600 un.
BTE 27086	Pendente c/ Rabicho Preto	e-27	4 A	0,5 a 2,5 mm ²	50 un.	600 un.
BTE 27083	Pendente c/ Rabicho Branco	e-27	4 A	0,5 a 2,5 mm ²	50 un.	600 un.

Base: E27

Corrente: 4 A

Tensão: 250 V

Bocais de Porcelana

Atende às normas de segurança e qualidade do INMETRO
Com borne embutido



Plafon
Base E27
BPO 27163



De Tempo
Base E27
BPO 27153



Desmontável Inclinado de Teto
Base E27
BPO 27023
*Ângulo de inclinação: 45°



Europeu (Boca Larga)
Base E40
BPO 40053



Para Plafonier
Base E27
BPO 27063



Para Spot com Alça
Base E27
BPO 27123



Para Spot
Base E27
BPO 27113



Para Spot Duplo Chanfrado
Base E27
BPO 27133



Para Spot Duplo Chanfrado Com Rabicho
Base E27
BPO 27143



Reforçado
Base E27
BPO 27093



Fixo de Teto
Base E27
BPO 27033



Fixo de Teto
Base E14
BPO 14033
* não possui borne

Bocais de Porcelana

CÓDIGO	DESCRIÇÃO	BASE	CORRENTE	FIOS E CABOS	EMBALAGEM	
					MID.	MASTER
BPO 14033	Fixo de Teto e-14	e-14	1 A	0,5 a 2,5 mm ²	25 un.	100 un.
BPO 27033	Fixo de Teto e-27	e-27	4 A	0,5 a 2,5 mm ²	25 un.	100 un.
BPO 27063	Para Plafonier	e-27	4 A	0,5 a 2,5 mm ²	25 un.	100 un.
BPO 27093	Reforçado	e-27	4 A	0,5 a 2,5 mm ²	25 un.	100 un.
BPO 27113	Para Spot	e-27	4 A	0,5 a 2,5 mm ²	25 un.	100 un.
BPO 27123	Para Spot com Alça	e-27	4 A	0,5 a 2,5 mm ²	25 un.	100 un.
BPO 27133	Para Spot Duplo Chanfrado	e-27	4 A	0,5 a 2,5 mm ²	25 un.	100 un.
BPO 27143	P/ Spot Duplo Chan. Rabicho	e-27	4 A	0,5 a 2,5 mm ²	25 un.	100 un.
BPO 27163	Plafon	e-27	4 A	0,5 a 2,5 mm ²	6 un.	60 un.
BPI 40053	Europeu (Boca Larga)	e-40	16 A	0,5 a 4,0 mm ²	25 un.	100 un.
BPO 27023	Desmontável Inclinado Teto	e-27	4 A	0,5 a 2,5 mm ²	10 un.	100 un.
BPO 27153	De Tempo	e-27	4 A	0,5 a 2,5 mm ²	25 un.	100 un.
BPO 40063	Liso e-40	e-40	16 A	0,5 a 4,0 mm ²	10 un.	100 un.

Base e-40

Sistema anti-vibratório "mola"

Sistema de travamento "mola triangular"

Contatos em latão niquelado

Acabamento em esmalte



Liso E40
BPO 40063

Bocais de Baquelite

Atente às normas de segurança e qualidade do INMETRO

Corpo em baquelite

Com borne embutido

CÓDIGO	DESCRIÇÃO	BASE	CORRENTE	FIOS E CABOS	EMBALAGEM	
					MID.	MASTER
BBQ 27053	Pendente com Chave	e-27	4A	0,5 a 2,5mm ²	20 un.	400 un.
BBQ 27063	Pendente sem Chave	e-27	4A	0,5 a 2,5mm ²	12 un.	600 un.



Pendente sem Chave
Base E27
BBQ 27063

Ideal para
instalações em geral,
provisórias ou definitivas



Pendente com Chave
Base E27
BBQ 27053

Ideal para
ambientes de difícil acesso
e instalações provisórias



Borne embutido

Tomada de Sobrepor de Porcelana Padrão ABNT

Mais segurança
e robustez
para sua instalação



2 P + T / 25 A
TEP 22523

CÓDIGO	CORRENTE	PÓLOS	EMBALAGEM	
			MID.	MASTER
TEP 22523	25 A	2 P + T	10 un.	100 un.

Tomadas de Sobrepor de Porcelana

Atende às normas de segurança e qualidade do INMETRO
Tensão Máxima 380V

CÓDIGO	CORRENTE	PÓLOS	EMBALAGEM	
			MID.	MASTER
TEP 12523	25 A	2 P	10 un.	100 un.
TEP 12533	25 A	3 P	10 un.	100 un.
TEP 13023	30 A	2 P	10 un.	100 un.
TEP 13033	30 A	3 P	10 un.	100 un.



2 Pólos / 25 A
TEP 12523



2 Pólos / 30 A
TEP 12523



3 Pólos / 25 A
TEP 12533



3 Pólos / 30 A
TEP 13033

Plugues para Tomadas de Porcelana

Atende às normas de segurança e qualidade do INMETRO
Tensão Máxima 380V

CÓDIGO	CORRENTE	PÓLOS	EMBALAGEM	
			MID.	MASTER
PTP 12523	25 A	2 P	10 un.	100 un.
PTP 12533	25 A	3 P	10 un.	100 un.
PTP 13023	30 A	2 P	10 un.	100 un.
PTP 13033	30 A	3 P	10 un.	100 un.



2 Pólos / 25 A
PTP 12523



2 Pólos / 30 A
PTP 13023



3 Pólos / 25 A
PTP 12533



3 Pólos / 30 A
PTP 13033

Conectores de Porcelana

Atende às normas de segurança e qualidade do INMETRO
Acabamento em esmalte



2 Pólos / 10 mm
CPO 11023

2 Pólos / 16 mm
CPO 11623

CÓDIGO	BITOLA MÁXIMA	PÓLOS	EMBALAGEM	
			MID.	MASTER
CPO 11023	10 mm	2 P	50 un.	1.000 un.
CPO 11033	10 mm	3 P	50 un.	1.000 un.
CPO 11623	16 mm	2 P	50 un.	300 un.
CPO 11633	16 mm	3 P	50 un.	300 un.



3 Pólos / 10 mm
CPO 11033

3 Pólos / 16 mm
CPO 11633

Fita Isolante de PVC Antichama

Classe de Tensão: 750 V
Classe de Temperatura: 90°
Flamabilidade: Auto-extinguível



CÓDIGO	COR	DIMENSÕES	EMBALAGEM	
			PACOTE	MASTER
FIS 13051	Amarela	18 mm x 0,13 mm x 5 m	10 un.	300 un.
FIS 13052	Azul	18 mm x 0,13 mm x 5 m	10 un.	300 un.
FIS 13053	Branca	18 mm x 0,13 mm x 5 m	10 un.	300 un.
FIS 13054	Cinza	18 mm x 0,13 mm x 5 m	10 un.	300 un.
FIS 13056	Preta	18 mm x 0,13 mm x 5 m	10 un.	300 un.
FIS 13057	Verde	18 mm x 0,13 mm x 5 m	10 un.	300 un.
FIS 13058	Vermelha	18 mm x 0,13 mm x 5 m	10 un.	300 un.
FIS 13101	Amarela	18 mm x 0,13 mm x 10 m	10 un.	200 un.
FIS 13102	Azul	18 mm x 0,13 mm x 10 m	10 un.	200 un.
FIS 13103	Branca	18 mm x 0,13 mm x 10 m	10 un.	200 un.
FIS 13104	Cinza	18 mm x 0,13 mm x 10 m	10 un.	200 un.
FIS 13106	Preta	18 mm x 0,13 mm x 10 m	10 un.	200 un.
FIS 13107	Verde	18 mm x 0,13 mm x 10 m	10 un.	200 un.
FIS 13108	Vermelha	18 mm x 0,13 mm x 10 m	10 un.	200 un.
FIS 13206	Preta	18 mm x 0,13 mm x 20 m	10 un.	200 un.

Disponível também em potes.

CÓDIGO	COR	DIMENSÕES	EMBALAGEM	
			POTE	MASTER
FIS 23056	Preta	18 mm x 0,13 mm x 5 m	50 un.	8 potes
FIS 23106	Preta	18 mm x 0,13 mm x 10 m	40 un.	8 potes
FIS 23206	Preta	18 mm x 0,13 mm x 20 m	25 un.	8 potes
FIS 23059	Sortida	18 mm x 0,13 mm x 5 m	50 un.	8 potes
FIS 23109	Sortida	18 mm x 0,13 mm x 10 m	40 un.	8 potes



Abraçadeiras de Nylon



Ideal para:

Sinalização de cabos, montagem de chicotes, fixação de cabos e fios, mangueiras, uso em automotivo, náutica e elétrica em geral



Auto travante
Evita abertura

Flamabilidade: Auto-extinguível UL94V-2

Temperatura de trabalho: -35°C a 85°C

Proteção anti-UV na cor preta

Nylon 6.6 de alta resistência

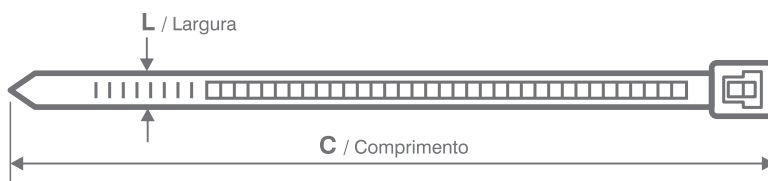

CÓDIGO	DIMENSÕES (L x C)	COR	DIÂMETRO AMARRA (mínimo - máximo)	TENSÃO RUPTURA (kgf / libra / N)	EMBALAGEM		
					PACOTE	MID	MASTER
ABN 25101	2,5 x 100 mm	Amarela	2 - 22 mm	18 / 8 / 78	100 un.	10 pcts.	500 pcts.
ABN 25102	2,5 x 100 mm	Azul	2 - 22 mm	18 / 8 / 78	100 un.	10 pcts.	500 pcts.
ABN 25103	2,5 x 100 mm	Branca	2 - 22 mm	18 / 8 / 78	100 un.	10 pcts.	500 pcts.
ABN 25104	2,5 x 100 mm	Cinza	2 - 22 mm	18 / 8 / 78	100 un.	10 pcts.	500 pcts.
ABN 25106	2,5 x 100 mm	Preta	2 - 22 mm	18 / 8 / 78	100 un.	10 pcts.	500 pcts.
ABN 25107	2,5 x 100 mm	Verde	2 - 22 mm	18 / 8 / 78	100 un.	10 pcts.	500 pcts.
ABN 25108	2,5 x 100 mm	Vermelha	2 - 22 mm	18 / 8 / 78	100 un.	10 pcts.	500 pcts.
ABN 25141	2,5 x 140 mm	Amarela	2 - 33 mm	18 / 8 / 78	100 un.	10 pcts.	250 pcts.
ABN 25142	2,5 x 140 mm	Azul	2 - 33 mm	18 / 8 / 78	100 un.	10 pcts.	250 pcts.
ABN 25143	2,5 x 140 mm	Branca	2 - 33 mm	18 / 8 / 78	100 un.	10 pcts.	250 pcts.
ABN 25144	2,5 x 140 mm	Cinza	2 - 33 mm	18 / 8 / 78	100 un.	10 pcts.	250 pcts.
ABN 25146	2,5 x 140 mm	Preta	2 - 33 mm	18 / 8 / 78	100 un.	10 pcts.	250 pcts.
ABN 25147	2,5 x 140 mm	Verde	2 - 33 mm	18 / 8 / 78	100 un.	10 pcts.	250 pcts.
ABN 25148	2,5 x 140 mm	Vermelha	2 - 33 mm	18 / 8 / 78	100 un.	10 pcts.	250 pcts.
ABN 25201	2,5 x 200 mm	Amarela	3 - 50 mm	18 / 8 / 78	100 un.	10 pcts.	250 pcts.
ABN 25202	2,5 x 200 mm	Azul	3 - 50 mm	18 / 8 / 78	100 un.	10 pcts.	250 pcts.
ABN 25203	2,5 x 200 mm	Branca	3 - 50 mm	18 / 8 / 78	100 un.	10 pcts.	250 pcts.
ABN 25204	2,5 x 200 mm	Cinza	3 - 50 mm	18 / 8 / 78	100 un.	10 pcts.	250 pcts.
ABN 25206	2,5 x 200 mm	Preta	3 - 50 mm	18 / 8 / 78	100 un.	10 pcts.	250 pcts.
ABN 25207	2,5 x 200 mm	Verde	3 - 50 mm	18 / 8 / 78	100 un.	10 pcts.	250 pcts.
ABN 25208	2,5 x 200 mm	Vermelha	3 - 50 mm	18 / 8 / 78	100 un.	10 pcts.	250 pcts.
ABN 35143	3,5 x 140 mm	Branca	3 - 33 mm	40 / 18 / 177	100 un.	10 pcts.	170 pcts.
ABN 35146	3,5 x 140 mm	Preta	3 - 33 mm	40 / 18 / 177	100 un.	10 pcts.	170 pcts.
ABN 35203	3,5 x 200 mm	Branca	3 - 50 mm	40 / 18 / 177	100 un.	10 pcts.	170 pcts.
ABN 35206	3,5 x 200 mm	Preta	3 - 50 mm	40 / 18 / 177	100 un.	10 pcts.	170 pcts.
ABN 35283	3,5 x 280 mm	Branca	3 - 70 mm	40 / 18 / 177	100 un.	10 pcts.	100 pcts.
ABN 35286	3,5 x 280 mm	Preta	3 - 70 mm	40 / 18 / 177	100 un.	10 pcts.	100 pcts.
ABN 45203	4,5 x 200 mm	Branca	3 - 50 mm	50 / 22 / 216	100 un.	10 pcts.	140 pcts.
ABN 45206	4,5 x 200 mm	Preta	3 - 50 mm	50 / 22 / 216	100 un.	10 pcts.	140 pcts.
ABN 45283	4,5 x 280 mm	Branca	3 - 70 mm	50 / 22 / 216	100 un.	10 pcts.	80 pcts.
ABN 45286	4,5 x 280 mm	Preta	3 - 70 mm	50 / 22 / 216	100 un.	10 pcts.	80 pcts.
ABN 47383	4,7 x 380 mm	Branca	3 - 102 mm	50 / 22 / 216	50 un.	10 pcts.	100 pcts.
ABN 47386	4,7 x 380 mm	Preta	3 - 102 mm	50 / 22 / 216	50 un.	10 pcts.	100 pcts.
ABN 67373	6,7 x 370 mm	Branca	4 - 98 mm	120 / 55 / 539	50 un.	10 pcts.	70 pcts.
ABN 67376	6,7 x 370 mm	Preta	4 - 98 mm	120 / 55 / 539	50 un.	10 pcts.	70 pcts.
ABN 90766	9,0 x 760 mm	Preta	10 - 225 mm	175 / 80 / 785	50 un.	---	20 pcts.
ABN 90926	9,0 x 920 mm	Preta	10 - 265 mm	175 / 80 / 785	50 un.	---	20 pcts.
ABN 91156	9,0 x 1.150 mm	Preta	10 - 310 mm	175 / 80 / 785	25 un.	---	40 pcts.
ABN 91356	9,0 x 1.350 mm	Preta	10 - 380 mm	175 / 80 / 785	25 un.	---	40 pcts.
ABN 93546	12,7 x 540mm	Preta	14 - 155 mm	250 / 114 / 1.118	25 un.	---	50 pcts.

ABN 93546: ideal para situações de alta tensão de ruptura.

* pcts = pacotes

Anunciadores e Alarmes



2em1
2 funções em
1 único equipamento



Anunciador de Presença e Alarma com Sensor Infravermelho
ANA 20111

3 pilhas AA (não inclusas)

Alarma de Janela e Anunciador de Presença
ANA 10111

Acionamento por contato magnético
3 baterias LR44 1,5 V (inclusas)
Fixação: Fita adesiva (ver quadro abaixo)

Alarma de Janela e Anunciador de Presença: Instalação fácil e rápida

CÓDIGO	SOM	EMBALAGEM	
		MID.	MASTER
ANA 10111	90 dB	10 un.	200 un.
ANA 20111	85 dB	—	50 un.



1) Retirar a proteção da Fita Adesiva Dupla Face

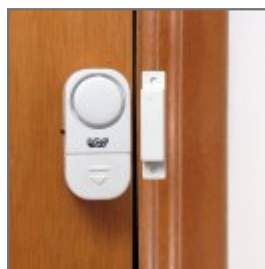

2) Fixar o alarme na porta, janela ou outros e pronto!



3) O dispositivo aciona com a abertura da porta ou janela

Conectores de Porcelana

Para lâmpada dicróica
Para uso abrigado
Dimerizável
Saída: 12 V



Dimerizável

CÓDIGO	POTÊNCIA MÁXIMA	TENSÃO	EMBALAGEM	
			MID.	MASTER
TLD 15011	50 W	127 V	10 un.	200 un.
TLD 25011	50 W	220 V	10 un.	200 un.

Antenas Externas para TV

**Compatível
com TV Digital**



Super Compacta
ATV 50103

*Plástico anti-UV: Maior resistência ao sol
4 em 1: VHF, UHF, HDTV e FM
Partes metálicas em alumínio
Grampo de fixação ajustável
Instalação fácil e rápida*



Super Flat
ATV 50104



Embalagem atrativa para PDV



Compacta Amplificada
ATV 51103

*Amplificador Autovolt 127/220V
*Dipolos pré-instalados

CÓDIGO	MODELO	EMBALAGEM
		MASTER
ATV 50103	Externa Super Compacta	8 un.
ATV 50104	Externa Super Flat	6 un.
ATV 51103	Externa Compacta Amplificada	10 un.
ATV 50102	Externa Super Compacta Digital	?? un.

*Colocar as mesmas informações?
HDTV e UHF*

**Exclusiva
para sinal digital
Full HD**



Super Compacta Digital
ATV 50102

Antenas Internas para TV



Miniparabólica Circular
ATV 11508



Miniparabólica Retangular
ATV 21508



Tipo V com Base
ATV 41508

**Compatível
com TV Digital**

Com chave seletora para melhor sintonia
4 em 1: VHF, UHF, HDTV e FM
Compatível com TV Digital



Tipo V 70 cm
TV VHF
ATV 31407



Tipo V 80 cm
TV VHF
ATV 31508

CÓDIGO	MODELO	HASTE		EMBALAGEM
		SEÇÕES	COMPRIMENTO	MASTER
ATV 11508	Interna Mini-parabólica Circular	5	80 cm	40 un.
ATV 21508	Interna Mini-parabólica Retangular	5	80 cm	40 un.
ATV 31407	Interna Tipo V	4	70 cm	200 un.
ATV 31508	Interna Tipo V	5	80 cm	200 un.
ATV 41508	Interna Tipo V com Base	5	80 cm	50 un.

Tipo V

Sem chave seletora

TV VHF

Não compatível com TV Digital

Suporte para Antena Externa de TV

Suporte opcional para instalação de antena externa em sacadas, paredes laterais ou telhados
Não acompanha a Antena, vendido separadamente



Suporte
SUP 22111



Suporte opcional

Para instalação em sacadas, paredes laterais ou telhados.
Vendido separadamente.

CÓDIGO	MODELO	EMBALAGEM
		MASTER
SUP 22111	Suporte para Antena Externa TV	30 un.

Suporte para TV

Acompanha jogos de parafusos, buchas e manual

Uso exclusivo para TV's e monitores de 10" a 72"

Suporte em aço com pintura eletrostática

Afastamento da parede: 3,5 cm

Suporte fixo (sem inclinação)

Sustenta até 100 kg



Suporte instalado na TV

Ideal para:
Monitores e TVs
(LED, Plasma e LCD)
de 10" a 72"



Fixo Universal
SUP 52111

De 10" a 72"



Embalagem atrativa para PDV

CÓDIGO	MODELO	EMBALAGEM
		MASTER
SUP 52111	Suporte para TV Fixo Universal	20 un.

Instalação fácil e rápida:

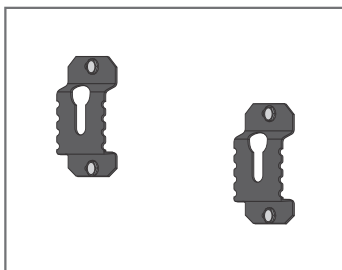

1) Fixar o **Suporte para TV G20** na parede a ser instalada a TV/ Monitor.

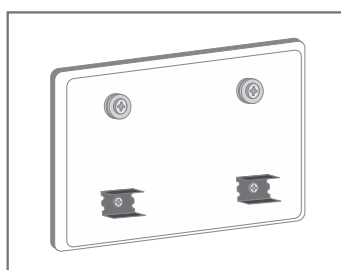

2) Fixar as roldanas e o suporte inferior na sua TV/ Monitor.

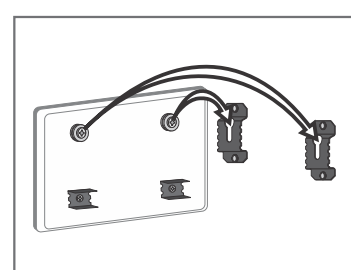

3) Encaixar as roldanas no suporte e pronto!

Importante: seguir corretamente as instruções contidas no manual que acompanha o produto

Temporizadores



Analógico

Múltiplas programações
Intervalo mínimo: 15 minutos
Programação repetida diariamente

Plugue Analógico Autovolt
TMP 10111

Barramento Analógico Autovolt
TMP 20111



Digital

8 programações
Intervalo mínimo: 1 minuto
Programa para 1 dia da semana
específico ou para dias intercalados

Plugue Digital Autovolt
TMP 10211

Barramento Digital Autovolt
TMP 20211

Digital para Trilho 220 V
TMP 32211



Embalagem atrativa para PDV



Plugue de acordo com NBR 14136

CÓDIGO	MODELO	CORRENTE	POTÊNCIA MÁXIMA RESISTIVA		EMBALAGEM	
			127 V	220 V	MID.	MASTER
TMP 10111	Plugue Analógico Autovolt	10 A	2.000 W	3.500 W	10 un.	50 un.
TMP 10211	Plugue Digital Autovolt	10 A	2.000 W	3.500 W	10 un.	50 un.
TMP 20111	Barramento Analógico Autovolt	16 A	2.000 W	3.500 W	10 un.	50 un.
TMP 20211	Barramento Digital Autovolt	16 A	2.000 W	3.500 W	10 un.	50 un.
TMP 32211	Trilho Digital 220 V	16 A	2.000 W	3.500 W	10 un.	40 un.

Conector Termoplástico em Barra



CÓDIGO	SEÇÃO DO CONDUTOR	MATERIAL	COR	EMBALAGEM	
				PACOTE	MASTER
CTB 10420	04 mm ²	Poliétileno (PE)	Translúcida	10 un.	100 pcts.
CTB 10620	06 mm ²	Poliétileno (PE)	Translúcida	10 un.	50 pcts.
CTB 11010	10 mm ²	Poliamida (PA)	Translúcida	10 un.	50 pcts.
CTB 11016	10 mm ²	Poliamida (PA)	Preta	10 un.	50 pcts.
CTB 11610	16 mm ²	Poliamida (PA)	Translúcida	10 un.	20 pcts.
CTB 11616	16 mm ²	Poliamida (PA)	Preta	10 un.	20 pcts.
CTB12510	25 mm ²	Poliamida (PA)	Translúcida	10 un.	20 pcts.
CTB12516	25 mm ²	Poliamida (PA)	Preta	10 un.	20 pcts.

* pcts = pacotes

Conector Pré-isolado



Conector Pré-isolado de Torção Com Borda

CÓDIGO	SEÇÃO DO CONDUTOR	COR	DIMENSÕES		EMBALAGEM		
			L	D	PACOTE	MID.	MASTER
CTE 11022	2,5 - 10,0 mm ²	Amarela	22 mm	19 mm	100 un.	10 pcts.	100 pcts.
CTE 10629	4,0 - 6,0 mm ²	Vermelha	29 mm	22 mm	100 un.	10 pcts.	100 pcts.

* pcts = pacotes

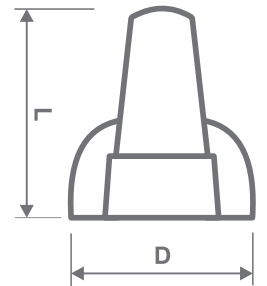

Conector Pré-isolado de Torção Sem Borda

CÓDIGO	SEÇÃO DO CONDUTOR	COR	DIMENSÕES		EMBALAGEM		
			L	D	PACOTE	MID.	MASTER
CTE 20115	0,5 - 1,0 mm ²	Cinza	15 mm	8,7 mm	100 un.	10 pcts.	150 pcts.
CTE 20218	0,5 - 2,5 mm ²	Azul	18 mm	10 mm	100 un.	10 pcts.	125 pcts.
CTE 20423	1,0 - 4,0 mm ²	Laranja	23 mm	11,2 mm	100 un.	10 pcts.	100 pcts.
CTE 20624	1,0 - 6,0 mm ²	Amarela	24,2 mm	13,6 mm	100 un.	10 pcts.	60 pcts.
CTE 21027	2,5 - 10,0 mm ²	Vermelha	27,8 mm	16,1 mm	100 un.	10 pcts.	50 pcts.

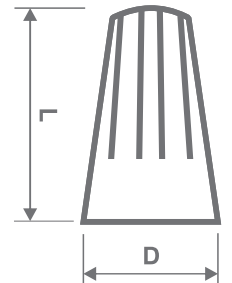

Tubo Pré-isolado para Emenda

CÓDIGO	SEÇÃO DO CONDUTOR	COR	DIMENSÕES			EMBALAGEM		
			L	H	D	PACOTE	MID.	MASTER
TPE 10126	0,5 - 1,5 mm	Vermelha	26 mm	15 mm	1,7 mm	100 un.	10 pcts.	120 pcts.
TPE 10226	1,5 - 2,5 mm	Azul	26 mm	15 mm	2,3 mm	100 un.	10 pcts.	128 pcts.
TPE 10626	4,0 - 6,0 mm	Amarela	26 mm	15 mm	3,4 mm	100 un.	10 pcts.	60 pcts.
TPE 11032	6,0 - 10,0 mm	Vermelha	32 mm	21 mm	4,5 mm	100 un.	10 pcts.	20 pcts.

* pcts = pacotes

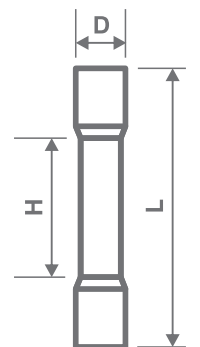

Terminal Totalmente Isolado

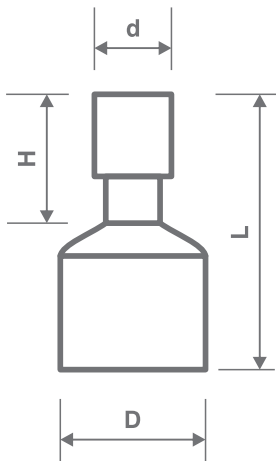

Terminal Totalmente Isolado Macho
Ideal p/ conexões em instalações energizadas



CÓDIGO	SEÇÃO DO CONDUTOR	DIMENSÕES				CORRENTE MÁXIMA	COR	EMBALAGEM		
		L	H	d	D			PACOTE	MID.	MASTER
TTM 10123	0,5 - 1,5 mm ²	23,0 mm	11,0 mm	4,0 mm	6,35 mm	10 A	Vermelha	100 un.	10 pcts.	80 pcts.
TTM 10224	1,5 - 2,5 mm ²	24,0 mm	11,0 mm	4,0 mm	6,35 mm	15 A	Azul	100 un.	10 pcts.	80 pcts.
TTM 10625	4,0 - 6,0 mm ²	25,0 mm	13,0 mm	6,3 mm	6,35 mm	24 A	Amarela	100 un.	10 pcts.	60 pcts.

* pcts = pacotes

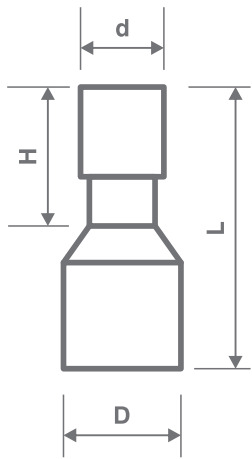

Terminal Totalmente Isolado Fêmea
Ideal p/ conexões em instalações energizadas



CÓDIGO	SEÇÃO DO CONDUTOR	DIMENSÕES				CORRENTE MÁXIMA	COR	EMBALAGEM		
		L	H	d	D			PACOTE	MID.	MASTER
TTF 10122	0,5 - 1,5 mm ²	22,0 mm	11,0 mm	4,0 mm	6,6 mm	10 A	Vermelha	100 un.	10 pcts.	120 pcts.
TTF 10222	1,5 - 2,5 mm ²	22,0 mm	11,0 mm	4,0 mm	6,6 mm	15 A	Azul	100 un.	10 pcts.	120 pcts.
TTF 10624	4,0 - 6,0 mm ²	24,0 mm	13,0 mm	6,3 mm	6,6 mm	24 A	Amarela	100 un.	10 pcts.	80 pcts.

* pcts = pacotes

Terminal de Compressão de Cobre Estanhado

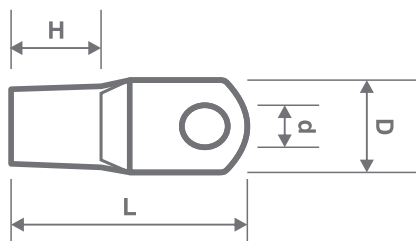

CÓDIGO	SEÇÃO DO CONDUTOR	DIMENSÕES				EMBALAGEM		
		L	H	d	D	PACOTE	MID.	MASTER
TCC 11001	1,5 mm ²	16 mm	6,5 mm	5,2 mm	8 mm	100 un.	30 pcts.	240 pcts.
TCC 11002	2,5 mm ²	20 mm	7 mm	5,2 mm	10 mm	100 un.	20 pcts.	160 pcts.
TCC 11004	4,0 mm ²	20 mm	7,5 mm	5,2 mm	10 mm	100 un.	10 pcts.	80 pcts.
TCC 11006	6,0 mm ²	23 mm	8 mm	5,2 mm	10 mm	100 un.	10 pcts.	80 pcts.
TCC 11010	10,0 mm ²	25 mm	9 mm	6,5 mm	12 mm	100 un.	8 pcts.	64 pcts.
TCC 11016	16,0 mm ²	30 mm	11 mm	6,5 mm	12 mm	50 un.	10 pcts.	80 pcts.
TCC 11025	25,0 mm ²	33 mm	13,5 mm	6,5 mm	13 mm	50 un.	6 pcts.	48 pcts.
TCC 11035	35,0 mm ²	38 mm	14,5 mm	8,4 mm	15,3 mm	50 un.	4 pcts.	32 pcts.
TCC 11050	50,0 mm ²	45 mm	17 mm	10,5 mm	17,8 mm	50 un.	2 pcts.	16 pcts.
TCC 11070	70,0 mm ²	50 mm	19,5 mm	10,5 mm	21 mm	50 un.	2 pcts.	16 pcts.
TCC 11095	95,0 mm ²	55 mm	23,5 mm	10,5 mm	25 mm	10 un.	5 pcts.	40 pcts.
TCC 11120	120,0 mm ²	63 mm	26 mm	13 mm	28 mm	10 un.	5 pcts.	40 pcts.
TCC 11150	150,0 mm ²	70 mm	29 mm	17 mm	30 mm	10 un.	5 pcts.	20 pcts.
TCC 11185	185,0 mm ²	75 mm	33 mm	17 mm	34 mm	10 un.	5 pcts.	20 pcts.
TCC 11240	240,0 mm ²	90 mm	40 mm	21 mm	38 mm	10 un.	3 pcts.	12 pcts.
TCC 11300	300,0 mm ²	98 mm	44 mm	21 mm	43 mm	10 un.	3 pcts.	12 pcts.

* pcts = pacotes

Terminal Pré-Isolado



Terminal Pré Isolado Tubular Simples



Terminal Pré Isolado Tubular Duplo

Terminal Pré-isolado Tipo Tubo

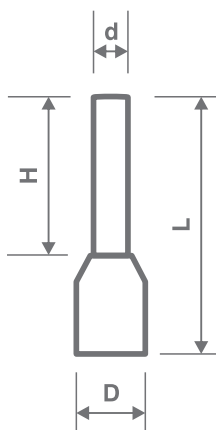

CÓDIGO	SEÇÃO DO CONDUTOR	DIMENSÕES				COR	EMBALAGEM		
		L	H	d	D		PACOTE	MID.	MASTER
TPT 10014	1 x 0,50 mm ²	14,0 mm	8 mm	1,3 mm	2,6 mm	Branca	100 un.	10 pcts.	720 pcts.
TPT 10015	1 x 0,75 mm ²	14,6 mm	8 mm	1,5 mm	2,8 mm	Cinza	100 un.	10 pcts.	600 pcts.
TPT 10014	0,75 mm ²	14,6 mm	8 mm	1,5 mm	2,8 mm	Cinza	100 un.	10 pcts.	600 pcts.
TPT 10114	1,0 mm ²	14,6 mm	8 mm	1,7 mm	3 mm	Vermelha	100 un.	10 pcts.	600 pcts.
TPT 10116	1,5 mm ²	16,4 mm	10 mm	2 mm	3,5 mm	Preta	100 un.	10 pcts.	480 pcts.
TPT 10215	2,5 mm ²	15,2 mm	8 mm	2,6 mm	4,0 mm	Azul	100 un.	10 pcts.	480 pcts.
TPT 10419	4,0 mm ²	19,5 mm	12 mm	3,2 mm	4,4 mm	Cinza	100 un.	10 pcts.	240 pcts.
TPT 10620	6,0 mm ²	20,9 mm	12 mm	3,9 mm	6,3 mm	Amarela	100 un.	10 pcts.	180 pcts.
TPT 11027	10,0 mm ²	27,5 mm	18 mm	4,9 mm	7,6 mm	Vermelha	100 un.	10 pcts.	96 pcts.
TPT 11628	16,0 mm ²	28,2 mm	18 mm	6,2 mm	8,8 mm	Azul	100 un.	10 pcts.	72 pcts.
TPT 12529	25,0 mm ²	29,8 mm	16 mm	7,9 mm	11,2 mm	Amarela	100 un.	10 pcts.	48 pcts.
TPT 13539	1 x 35,0 mm ²	39,0 mm	25 mm	8,7 mm	12,7 mm	Vermelha	100 un.	10 pcts.	180 pcts.
TPT 20014	2 x 0,50 mm ²	14,5 mm	8 mm	1,8 mm	5,0 mm	Branca	100 un.	10 pcts.	540 pcts.
TPT 20015	2 x 0,75 mm ²	14,7 mm	8 mm	2,1 mm	5,5 mm	Azul	100 un.	10 pcts.	480 pcts.
TPT 20115	2 x 1,0 mm ²	15,1 mm	8 mm	2,3 mm	5,5 mm	Vermelha	100 un.	10 pcts.	420 pcts.
TPT 20116	2 x 1,5 mm ²	15,5 mm	8 mm	2,6 mm	6,4 mm	Preta	100 un.	10 pcts.	240 pcts.
TPT 20218	2 x 2,5 mm ²	18,5 mm	10 mm	3,3 mm	8,0 mm	Cinza	100 un.	10 pcts.	180 pcts.
TPT 20423	2 x 4,0 mm ²	23,1 mm	12 mm	4,2 mm	8,8 mm	Laranja	100 un.	10 pcts.	120 pcts.
TPT 20626	2 x 6,0 mm ²	26,1 mm	14 mm	5,3 mm	9,5 mm	Amarela	100 un.	10 pcts.	96 pcts.
TPT 21027	2 x 10,0 mm ²	26,6 mm	14 mm	6,9 mm	12,6 mm	Vermelha	100 un.	10 pcts.	48 pcts.
TPT 21631	2 x 16,0 mm ²	31,3 mm	14 mm	8,7 mm	19,0 mm	Azul	100 un.	10 pcts.	24 pcts.

* pcts = pacotes



Terminal Pré-isolado Tipo Anel

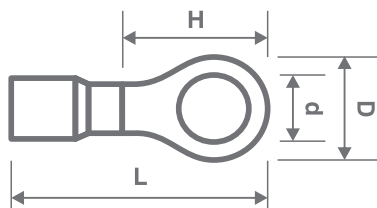

CÓDIGO	SEÇÃO DO CONDUTOR	DIMENSÕES				COR	EMBALAGEM		
		L	H	d	D		PACOTE	MID.	MASTER
TPA 10103	0,5 - 1,5 mm ²	21,5 mm	11,5 mm	3,7 mm	8 mm	Vermelha	100 un.	10 pcts.	180 pcts.
TPA 10104	0,5 - 1,5 mm ²	21,5 mm	11,5 mm	4,3 mm	8 mm	Vermelha	100 un.	10 pcts.	240 pcts.
TPA 10105	0,5 - 1,5 mm ²	21,5 mm	11,5 mm	5,3 mm	8 mm	Vermelha	100 un.	10 pcts.	240 pcts.
TPA 10106	0,5 - 1,5 mm ²	27,5 mm	17,5 mm	6,5 mm	11,6 mm	Vermelha	100 un.	10 pcts.	180 pcts.
TPA 10108	0,5 - 1,5 mm ²	27,5 mm	17,5 mm	8,4 mm	11,6 mm	Vermelha	100 un.	10 pcts.	120 pcts.
TPA 10203	1,5 - 2,5 mm ²	22,5 mm	12,5 mm	3,7 mm	8,5 mm	Azul	100 un.	10 pcts.	180 pcts.
TPA 10204	1,5 - 2,5 mm ²	22,5 mm	12,5 mm	4,3 mm	8,5 mm	Azul	100 un.	10 pcts.	180 pcts.
TPA 10205	1,5 - 2,5 mm ²	22,5 mm	12,5 mm	5,3 mm	9,5 mm	Azul	100 un.	10 pcts.	180 pcts.
TPA 10206	1,5 - 2,5 mm ²	27,6 mm	17,6 mm	6,5 mm	12 mm	Azul	100 un.	10 pcts.	120 pcts.
TPA 10208	1,5 - 2,5 mm ²	27,6 mm	17,6 mm	8,4 mm	12 mm	Azul	100 un.	10 pcts.	120 pcts.
TPA 10603	4,0 - 6,0 mm ²	21,4 mm	8,9 mm	3,7 mm	7,2 mm	Amarela	100 un.	10 pcts.	120 pcts.
TPA 10604	4,0 - 6,0 mm ²	25,5 mm	13 mm	4,3 mm	9,5 mm	Amarela	100 un.	10 pcts.	100 pcts.
TPA 10605	4,0 - 6,0 mm ²	25,5 mm	13 mm	5,3 mm	9,5 mm	Amarela	100 un.	10 pcts.	80 pcts.
TPA 10606	4,0 - 6,0 mm ²	31,5 mm	19 mm	6,5 mm	12 mm	Amarela	100 un.	10 pcts.	80 pcts.
TPA 10608	4,0 - 6,0 mm ²	31,5 mm	21,2 mm	8,4 mm	15 mm	Amarela	100 un.	10 pcts.	80 pcts.
TPA 10610	4,0 - 6,0 mm ²	33,7 mm	21,2 mm	10,5 mm	15 mm	Amarela	100 un.	10 pcts.	60 pcts.

* pcts = pacotes

Terminal Pré-Isolado

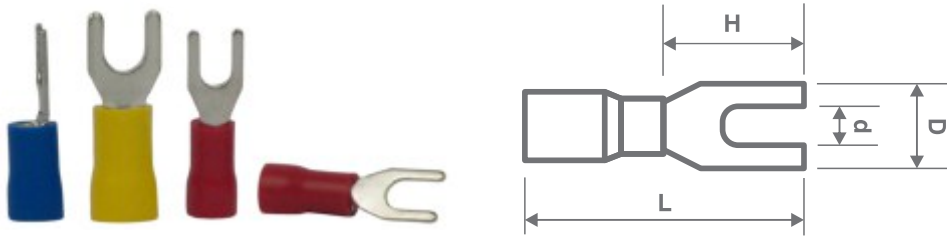

Terminal Pré-isolado Tipo Garfo

CÓDIGO	SEÇÃO DO CONDUTOR	DIMENSÕES				COR	EMBALAGEM		
		L	H	d	D		PACOTE	MID.	MASTER
TPG 10103	0,5 - 1,5 mm ²	21,2 mm	11,2 mm	3,7 mm	6,4 mm	Vermelha	100 un.	10 pcts.	240 pcts.
TPG 10104	0,5 - 1,5 mm ²	21,2 mm	11,2 mm	4,3 mm	6,4 mm	Vermelha	100 un.	10 pcts.	240 pcts.
TPG 10203	1,5 - 2,5 mm ²	21,2 mm	11,2 mm	3,7 mm	6,4 mm	Azul	100 un.	10 pcts.	240 pcts.
TPG 10204	1,5 - 2,5 mm ²	21,2 mm	11,2 mm	4,3 mm	6 mm	Azul	100 un.	10 pcts.	240 pcts.
TPG 10205	1,5 - 2,5 mm ²	21,2 mm	11,2 mm	5,3 mm	8,1 mm	Azul	100 un.	10 pcts.	180 pcts.
TPG 10604	4,0 - 6,0 mm ²	25,2 mm	12,7 mm	4,3 mm	8,3 mm	Amarela	100 un.	10 pcts.	140 pcts.
TPG 10605	4,0 - 6,0 mm ²	24 mm	11,5 mm	5,3 mm	9 mm	Amarela	100 un.	10 pcts.	140 pcts.

* pcts = pacotes

Terminal Pré-isolado Tipo Fêmea



CÓDIGO	SEÇÃO DO CONDUTOR	DIMENSÕES			COR	EMBALAGEM		
		L	H	D		PACOTE	MID.	MASTER
TPF 10121	0,5 - 1,5 mm ²	21 mm	11 mm	7,4 mm	Vermelha	100 un.	10 pcts.	180 pcts.
TPF 10221	1,5 - 2,5 mm ²	21 mm	11 mm	7,4 mm	Azul	100 un.	10 pcts.	200 pcts.
TPF 10625	4,0 - 6,0 mm ²	25 mm	11 mm	7,4 mm	Amarela	100 un.	10 pcts.	120 pcts.

* pcts = pacotes

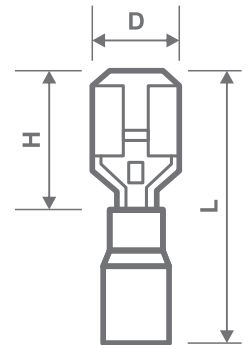

Terminal Pré-isolado Tipo Macho



CÓDIGO	SEÇÃO DO CONDUTOR	DIMENSÕES			COR	EMBALAGEM		
		L	H	D		PACOTE	MID.	MASTER
TPM 10121	0,5 - 1,5 mm ²	21 mm	11 mm	6,35 mm	Vermelha	100 un.	10 pcts.	240 pcts.
TPM 10221	1,5 - 2,5 mm ²	21 mm	11 mm	6,35 mm	Azul	100 un.	10 pcts.	240 pcts.
TPM 10625	4,0 - 6,0 mm ²	25 mm	11 mm	6,35 mm	Amarela	100 un.	10 pcts.	120 pcts.

* pcts = pacotes

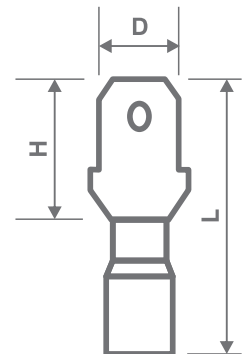

Terminal Pré-isolado Tipo Pino



CÓDIGO	SEÇÃO DO CONDUTOR	DIMENSÕES		COR	EMBALAGEM		
		L	H		PACOTE	MID.	MASTER
TPP 10120	0,5 - 1,5 mm ²	20 mm	10 mm	Vermelha	100 un.	10 pcts.	240 pcts.
TPP 10123	0,5 - 1,5 mm ²	23 mm	13 mm	Vermelha	100 un.	10 pcts.	180 pcts.
TPP 10220	1,5 - 2,5 mm ²	20 mm	10 mm	Azul	100 un.	10 pcts.	180 pcts.
TPP 10223	1,5 - 2,5 mm ²	23 mm	13 mm	Azul	100 un.	10 pcts.	180 pcts.
TPP 10625	4,0 - 6,0 mm ²	25,5 mm	13 mm	Amarela	100 un.	10 pcts.	70 pcts.

* pcts = pacotes

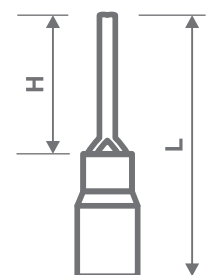

Refletores Fita Isolante Conectores Bases para Lâmina
Suporte para TV Alarmes e Anunciadores Luminária
Terminais Antenas Alarmes e Anunciadores Plugues



Refletores Fita Isolante Conectores Bases para Lâmina
Suporte para TV Alarmes e Anunciadores Luminária
Terminais Antenas Alarmes e Anunciadores Plugues
Luminárias Abraçadeira de Nylon Temporizadores
Refletores Fita Isolante Conectores Bases para Lâmina
Suporte para TV Alarmes e Anunciadores Luminária
Terminais Antenas Alarmes e Anunciadores Plugues
Luminárias Abraçadeira de Nylon Temporizadores
Refletores Fita Isolante Conectores Bases para Lâmina
Suporte para TV Alarmes e Anunciadores Luminária
Terminais Antenas Alarmes e Anunciadores Plugues
Luminárias Abraçadeira de Nylon Temporizadores



atendimento@g20brasil.com.br

0800 644 2220

www.g20brasil.com.br